

COMBi-4WSL 4500-6000

The 4 wheel Sideloader forklift designed for the safe, space saving and productive handling of long and bulky loads.

COMBiLiFT

LIFTING INNOVATION



combilift.com

COMBi-4WSL 4500-6000

SIDE VIEW

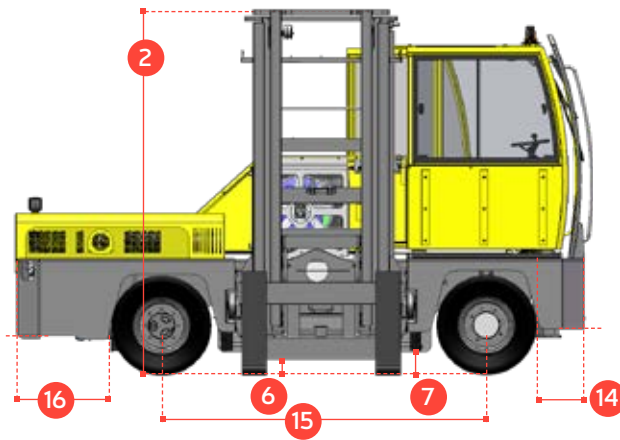

FRONT VIEW

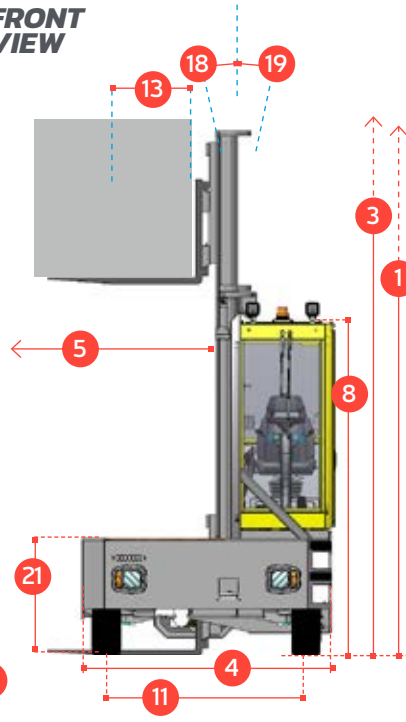

OVERHEAD VIEW

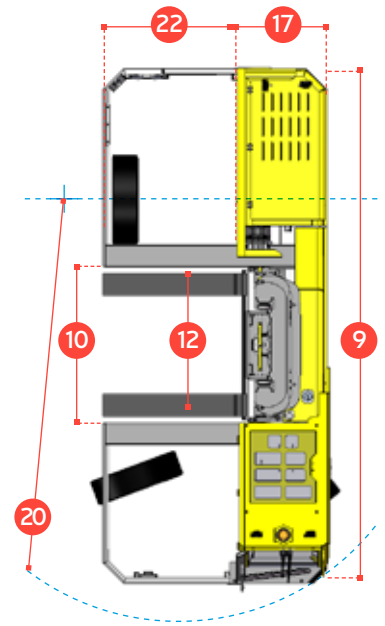

REF.	DESCRIPTION	5000 4WSL	6000 4WSL
1a	Max. Lift Height	4040mm	
1b	Freelift Height	0mm	
2	Height Mast Closed	3035mm	
3	Max. (Mast raised)	5150mm	
4	Overall Width	2000mm	2200mm
5	Mast Travel	1250mm	1450mm
6	Ground Clearance Under Mast	300mm	
7	Ground Clearance to Centre of Wheelbase	405mm	
8	Height Over Cab (Without work lights)	2730mm	
9	Length	4630mm	
10	Frame Opening	1400mm	
11	Track	1608mm	
12	Outside Spread of Fork Arms	1290mm	
13	Load Centre Distance	600mm	
14	Overhang Front	390mm	
15	Wheelbase	2650mm	
16	Overhang Back	800mm	
17	Length From Face of Fork	800mm	
18	Forward Tilt	3°	
19	Backward Tilt	5°	
20	Minimum Outside Radius	4200mm	
21	Platform Height	950mm	
22	Platform Length	1200mm	1400mm
A	Capacity	5000 kg	6000 kg
B	Unladen Weight	9500 kg	9500 kg
C	Maximum Ground Speed	25 km/h	
D	Gradeability	15%	
E	Deutz TCD 3.6 L4 (Stage IIIB) / 4.3 ltr GM LPG	75 kW	
F	Electrics	12 Volt	
G	Fork Section 50mm x 200mm x	1200mm	1400mm
H	Pneumatic/Super Elastic Front Tyre	8.25 - 15	300 - 15
I	Standard Colour	Yellow & Grey	
J	Suspension Seat	KAB Model 116	



Features Include:

- Hydraulic Suspended Cabin
- Wet Disc Brakes
- 2 Wheel Drive
- Load Sensing Steering
- Tilting Chassis
- Hydraulic Oil Cooler

Distributed by: